

CIMI

At Toyon Bay

Catalina Island Marine Institute



Teacher's D'Ubb]b['DUW_Yh

CIMI at Toyon Bay • P.O. Box 796 • Avalon, CA 90704

Phone 310.510.1622 • Fax 310.510.0685

Please complete the following:

- Hand out the parent letter medical form to each of the attending students and chaperones. Collect these forms and bring them with you to CIMI.
- Complete and return the Program Planner, Classroom Preparation Information, and Chaperone Agreement in the Self-Addressed Stamped Envelope enclosed.
- Make sure your student and chaperone male:female ratio fits into the dorms assigned. If the numbers do not fit, call the Assistant Program Director as soon as possible.

If you have any questions, please feel free to call the CIMI Program Office.

Important Numbers to Keep Handy

Guided Discoveries Business Office	909.625.6194
CIMI, Toyon Bay Program Office	310.510.1622
CIMI, Toyon Bay Program Office Fax	310.510.0685
CIMI, Toyon Bay Program Director (Jeff Chace)	310.510.1622 ext. 16
CIMI, Toyon Bay Assistant PD (Lauren Knox)	310.510.1622 ext. 13

Table of Contents

1.0
Group

Leader Information

1.1 Helpful Suggestions for the group leader

1.2 Timeline of Events

1.3 Program Planning

*To be returned
To the
Program Office
Prior to arrival*

Three-Day Program Planner or
Five-Day Program Planner
Classroom Prep Information Sheet
Statement of Understanding

Chaperone Release Form (Photocopy for each adult to sign)

Telephone Contact Sheet

Store Pre-order Form if desired

1.4 Student Health Form Organization

1.5 Toyon Bay Dorms & Map

1.6 Map to Ferry terminal / Arrival & Departure

2.0 Chaperone and Student information

2.1 Chaperone Information

2.2 Packing List

2.3 Safety Information

2.4 Meals

3.0 Program Descriptions

3.1 Day Programs

3.2 Evening Programs

1.0 GROUP LEADER INFORMATION:

1.1 HELPFUL SUGGESTIONS FOR THE GROUP LEADER

We are excited that you are bringing your students to Catalina Island! This will be a trip that the students will remember for the rest of their lives. We will do our best to make your trip an exceptional experience. We would like to offer a few reminders to help make your trip successful.

Student Health Forms:

Please check the completed medical forms for any medical conditions that may present a problem on your trip. Please notify our Assistant Program Director prior to your group's arrival of any food allergies or medical conditions that may be of concern. Please be sure that all asthmatics bring their prescribed inhalers with them to camp.

→ **Students with asthma who have a prescribed inhaler or other breathing device will not be allowed to participate in program unless the inhaler or device is in camp and functional.**

Check before you leave!!!

→ **Group leaders will be responsible for coordinating efforts to get inhalers or other devices to camp if they are not here upon arrival.**

We will collect the medical forms upon arrival. The forms will be available to you in our first aid room. We are required to keep the CIMI medical forms when you leave. Please make copies if you are using the same forms for your transportation purposes.

Chaperones:

Students are directly motivated by the chaperones. Be sure that your chaperones know what is expected of them in regards to participation, supervision and communal living. Chaperones are expected to participate in all programs. You will want to assign chaperones to monitor free-time activities as well. **Choose your chaperones carefully!**

→ **We require at least one male and one female chaperone to provide safe and adequate supervision in the dorms.**

→ **We may ask you to limit your chaperones to a ratio of one chaperone to every 15 students (this would only happen to avoid housing problems).**

Program Schedule:

Our Assistant Program Director will phone about two to three weeks prior to arrival for final student and chaperone count. We will discuss your daily schedule, the number of research groups, dorm assignments, boat details, and other pertinent details for your trip.

General reminders:

- Drugs or alcohol are not allowed in camp.
- Students are not allowed to smoke.
- Chaperones that smoke may only do so in designated areas.
- We are not responsible for valuables brought to camp.

We appreciate your desire to provide your students with a quality program. We will try to accommodate your individual needs in every way in which we are able. Please feel free to call us with any questions you may have.

1.2 TIMELINE OF EVENTS

When you receive this packet:

- ✓ Send parent information (application/medical form) to all parents.
- ✓ After reading through your syllabus, **RETURN** "Statement of Understanding/Program Prep Sheet" and the "Program Planner" from the Teacher's Syllabus to CIMI at Toyon Bay (Envelope enclosed).

TWO Weeks prior to departure:

- ✓ You will be contacted by the CIMI program office to cover details on the telephone contact sheet, including final count of students and chaperones, meal and medical information.
- ✓ Arrange transportation to Long Beach boat terminal. Call the business office if you need assistance with arrangements.
- ✓ Assign students to dorms.

ONE Week prior to departure - final checklist of organizational details:

- ✓ Prepare all chaperones and assign their duties.
- ✓ Copy and hand out pages from the "Chaperone and Student Information" section, along with copies of the chaperone release forms (tan sheet) for each chaperone to sign and bring with them.
- ✓ Divide students into study groups of 15 students.
- ✓ Finalize dorm assignments.
- ✓ Collect all completed medical forms from the students; note all medical needs, separate forms by group. Forms are due upon arrival.
- ✓ **Inform students that they must bring a sack lunch, unless you have ordered lunch.**

- ✓ Send home a copy of our "What to Bring List".
- ✓ Make sure all luggage is color tagged and named. ***We request you tag your luggage with yarn. Colored surveyors tape tends to rip off and end up all over the field and in the ocean. ***

Day or Two prior to departure:

- ✓ Remind students to bring a sack lunch.
- ✓ Draw final payment check (due upon arrival).

Departure Day:

- ✓ Make sure that students have brought sack lunches (if not, please call the Toyon office at 310.510.1622 so we can organize snacks for those students).
- ✓ **DOUBLE CHECK THAT ALL STUDENTS HAVE ASTHMA INHALERS, EPI-PENS OR ANY OTHER NEEDED LIFESAVING MEDICAL DEVICES.**

1.3 PROGRAM PLANNING

Study Groups:

You will need to divide your class(es) into study groups with 15 students per group maximum.

Some suggestions on how to divide your groups successfully:

- Mix boys and girls (unisex groups don't seem to work as well).
- Group ESL students together with a bilingual adult if possible.
- If possible, divide groups by athletic ability (snorkeling, hiking, kayaking- experienced vs. novice).
- Assign teachers who know the students to those groups with "challenging students" to help keep discipline in check.
- Keep numbers per group consistent (i.e., 16 in one group and 10 in another creates problems). Don't let students switch into other groups - keep a list.

The experiences we offer students often have a profound positive impact on their lives. This is equally true for the hard to reach, difficult students as it is for the average, responsible students. Teachers often bring difficult students with the hope that this experience will help generate some positive feedback.

If you choose to bring students who may present a challenge with respect to their behavior or discipline, we suggest that you place them in the same group as the Head Chaperone, or that of a teacher, so that some disciplinary leverage is present. If you have questions concerning this please feel free to contact us.

Each school's program is centered around the needs of the individuals of that school. There are a wide variety of activities available at CIMI: more activities than can be accomplished during a three- or five-day session. Each teacher must decide on the program sessions that will best meet the needs of their students. Do not try to pull all of the program components into this experience.

Prior to your arrival at Toyon, CIMI's Program Office will discuss the specifics of the activities with you. There are certain programs that are necessary, many that are optional. Each day has two three-hour program sessions and an evening session.

The number of program sessions depends on the length of stay:

Three-day programs: 4 day sessions; 2 evening sessions

Five-day programs: 8 day sessions; 4 evening sessions

1.4 MEDICAL FORM ORGANIZATION

In an effort to continue making CIMI at Toyon Bay the safest environment for your students, we are asking schools to organize their medical forms. We would appreciate it if you could please take a few moments to organize your groups and their forms in the following fashion prior to arrival:

1. Groups should be arranged so that the boys and girls are mixed and there is at least one chaperone per each group. Please try to divide the groups so that they all have about the same number of students.
2. Once you have decided the groups, please make a list and separate the students medical forms by group.
3. Once the medical forms are separated, please attach a sheet of paper to each group's medical forms with the following information on the front:

Name of School

Group #

Students Names

Adult Leader(s) Names(s) for that group

List any outstanding medical needs

4. The medical forms, now separated by group and identified with the above information, should all be brought with you to CIMI and given to the Program Coordinator of your school during the orientation meeting when you first arrive at camp.

→ So that we are best able to deal with potential medical problems, CIMI instructors will review the medical forms for each research group. This system will allow our staff, and yours, to best be aware of any potential medical conditions. Thanks you for taking the time to go through the forms; let us know if you have any questions.

→ Please remember that we are required by law to keep these medical forms on file. You should keep your school district forms separate from these for your return trip.

→ Please use discretion if you are presented with a student or chaperone arriving on your trip's departure day sick (i.e. fever, flu, or a cold). We understand that your students (and their parents) are looking forward to this trip, but due to its rustic and active program, Toyon Bay is NOT an ideal place to recover (or suffer through) an illness. **Do NOT** bring sick participants. We ask that you consider the affected person's comfort and the health and well being of the remaining students and CIMI staff.

Medical Form Cover Sheet Example

Name of School: TBMS Elementary School
Group #1

Student Names:

Liz Martin	Alyssa Bear	Kate Lowe	Justin Olenik
Robby Bair	Peter Mc Bride	Ernie Wheeler	Michael Yorke
Mary Ick	Phoebe Jekielek	Dani Di Iullo	Megan Bergie

Adult Leader: Mrs. Chace (Kat)

Outstanding Medicals: Liz Martin – Asthma
Kate Lowe – Diabetes

CIMI DORM ASSIGNMENT

1.5 TOYON BAY DORMS & MAP

NOTE: Due to changing group numbers and other needs, we may need to revise your housing assignments. If so, we will notify you of the changes.

UPPER QUAD

LOWER QUAD

ROOM # # OF BEDS

ROOM # # OF BEDS

ROOM # # OF BEDS

ALBATROSS 15

FRONT

210 3
211 4
212 3
213 4
215 1

ALBATROSS 21

BACK

220 4
222 2
223 3
224 4
225 4
226 4

TORQUA BACK 18

410 6
411 2
412 6
413 4

TORQUA FRONT 26

414 4
416 5
417 8
418 3
419 6

BALD EAGLE 37

501 2
502 5
503 6
504 4
505 4
506 2
507 8
508 6

BARRACUDA 41

601 3
602 3
603 4
604 5
605 2
606 6
607 6
608 4
609 2
610 2
611 2
612 2

PEPPERTREE 34

301 6
302 10
303 4*
304 6*
305 8

(*303 & 304 share a bathroom)

OWL 48

120 A 3
 B 10
 C 3
122 A 3
 B 10
 C 3
124 A 3
 B 10
 C 3

FLYING FISH 33

130 A 7
 B 3
132 A 7
 B 3
134 A 9
 B 4

CANTEEN 16

140 6
141 6
142 4

DOLPHIN 10

101 2
102 8

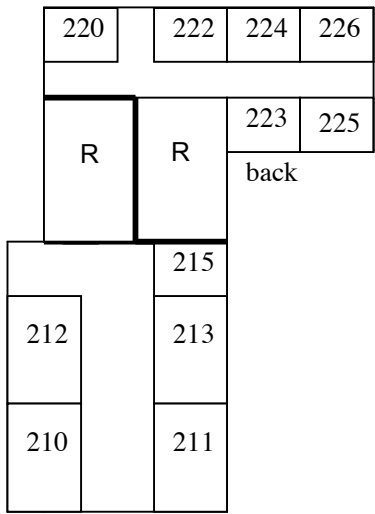

ALBATROSS

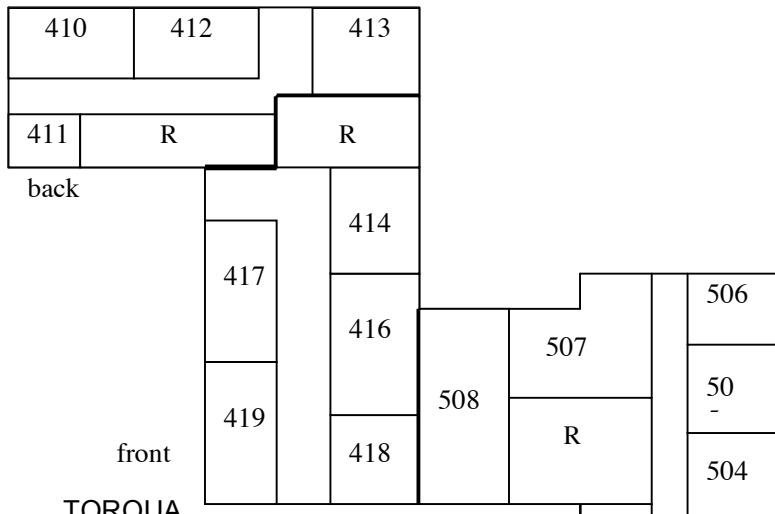

TORQUA

BALD EAGLE

BARRACUDA

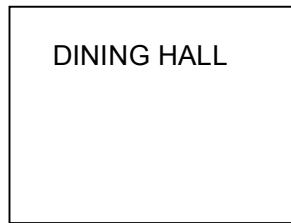

DINING HALL

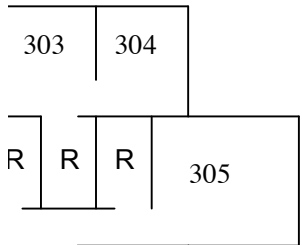
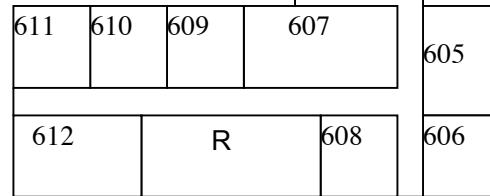

PEPPERTREE

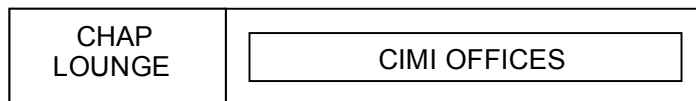

CHAP LOUNGE

CIMI OFFICES

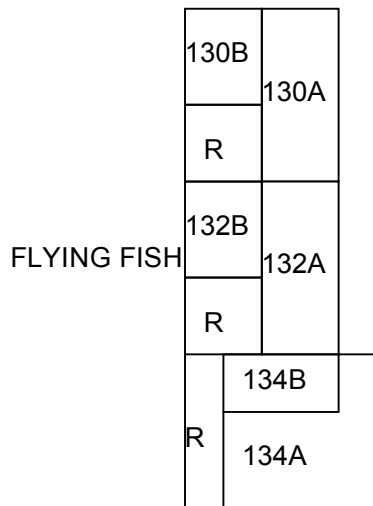

FLYING FISH

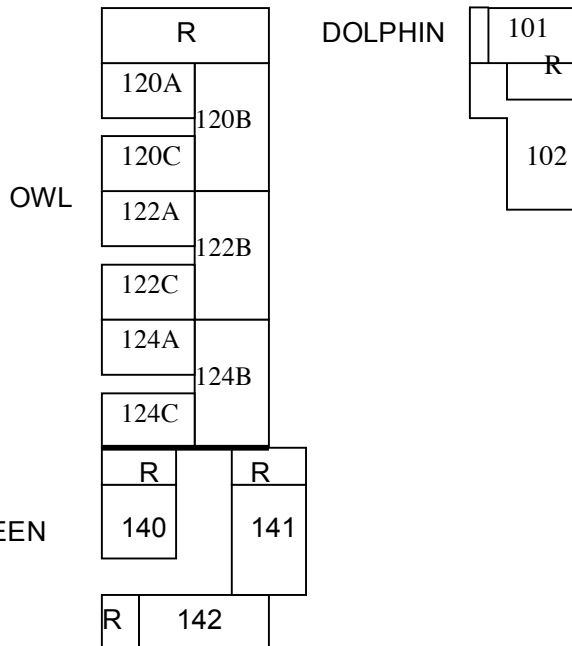

OWL

CANTEEN

DOLPHIN

1.6 TRAVEL, ARRIVAL AND DEPARTURE PROCEDURE

→ If this is your first trip to CIMI, please read carefully!

CIMI will make your boat reservations aboard the Catalina Classic Cruises, located at the Catalina Express Queen Mary terminal in Long Beach (see map). If you have any questions regarding the boat please call the mainland office **909.625.6194**

On departure from Long Beach, your group will go to Toyon Bay, however, the boat may stop at other camps before reaching Toyon. Make sure your students know which stop is theirs! We suggest that a teacher be stationed at the exit to make sure none of their students disembark at any other facility. This facilitates arrival, orientation, moving into the dorms and a timely start to the afternoon program.

Group leaders MUST contact the Toyon Bay office at least 2 weeks prior to arrival with their final count of students and chaperones attending. A drop in numbers after that time will result in a \$40.00 per person cancellation fee.

Have the students mark all of their luggage with your assigned school color. Thick pieces of yarn work well. Your school color will be given to you during your telephone contact 2 weeks prior to arrival.

Plan to arrive at the boat terminal at least one hour prior to departure time. Upon arrival at the Catalina Cruises office at the Queen Mary terminal, the group leader must check in and give the final numbers for their school. Groups will not use tickets for transportation.

The boat crew will give instructions for pre-loading your group's luggage. LISTEN CAREFULLY! The students must assist loading the luggage. The students must exit the boat after helping with the luggage. Re-group your students off the boat and wait until they instruct you to re-board. Please be aware that once the boat has your luggage on board they will not allow access to it until at Toyon Bay.

→ For a smooth voyage aboard the boat, please advise your students of the following;

- No running or rough-housing
- Stay seated whenever possible
- Pick up trash
- Don't feed the gulls
- Seasick medication should be taken one hour before departure

If possible, the group leader should carry a cell phone.

IMPORTANT: If you think you are going to be late for any reason, call our business office at **909.625.6194** with your anticipated time of arrival in Long Beach. We will do our best to have the cruise line hold the boat. However, this cannot be guaranteed. **Any group who misses their scheduled boat will be subject to a \$2.50 per person no-show charge and will also be disqualified from the CIMI group fare.**

**Directions to
Check-in for
Catalina Island
Marine Institute**

**Take the 710 fwy South
into Long Beach. Stay
in the right lane,
follow all signs to
Queen Mary which will
lead you to the Catalina
Express terminal inside
the Queen Mary gate.**

**If you get lost please
call our office at:
1-800-645-1423 or
909-625-6194**

CIMI at

- Toyon Bay
- Fox Landing
- Cherry Cove
- YMCA Camp Fox

Catalina Classic Cruises **Located next to the Queen Mary** **at the Catalina Express Terminal**

CIMI Check-in

1046 Queens Hwy, Long Beach Ca 90802

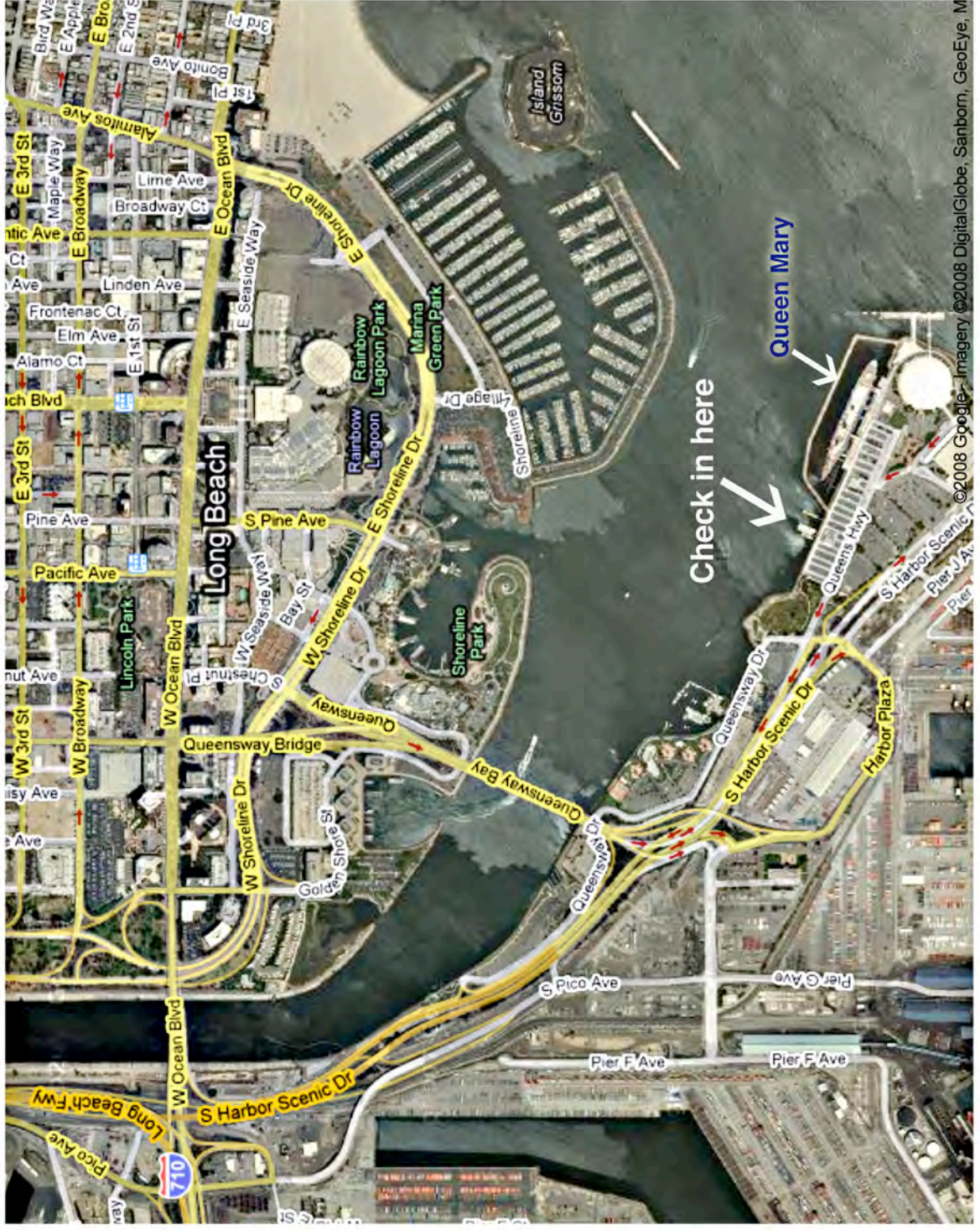

2.0 TEACHER AND STUDENT INFORMATION

2.1 TEACHER AND CHAPERONE INFORMATION:

CIMI programs are educational in focus. Although we strive to make them fun and interactive, this is not done at the expense of the learning environment. A CIMI instructor has at least a BS or BA degree and her or his energies are directed toward program activities. **They do not fulfill the role of a 'counselor' by supervising students during their free time, at meals or in the dorms. Participating adults supervise students during these times.**

We respect and encourage the adults who choose to participate with their school, group and/or child. Our program would not function at the level it does without their active involvement. We believe there are many rewards, both personal and group related, which will result from their efforts.

Chaperones should come prepared to participate in all program activities, including snorkeling and kayaking. This is an expectation of our program. Chaperones will also be in charge of the control, discipline and overall safety of the students both during program time and free time.

CIMI is not logistically in a position to accommodate 'free agents'; individuals who would like to do their own thing while at Toyon Bay. Examples include SCUBA diving or going off by oneself to explore other aspects of the program or island. Although adults are here to support the school's trip, individuals have arrived, on occasion, prepared to entertain themselves. We hope to avoid any disappointment by providing an overview of adult responsibilities and the procedures, which will influence your visit to Toyon Bay.

Role of Chaperones:

Program:

Be an active part of program, including snorkeling and kayaking. This sets the appropriate example for the students and provides support for the instructor. Help supervise during program. Our instructors' energy should go into teaching, not disciplining.

First Aid:

IF a student has a minor injury or illness, a chaperone escorts the student to CIMI's first aid room. This room is stocked with medication and supplies. Chaperone must consult the student's medical form before administering fist aid. After treatment or medication is given, the chaperone must log the assistance given in the CIMI medical logbook.

Facility:

Supervise students during free time and in the dorms. To curtail rough horseplay, keep students within their boundaries. **Students should always be with a chaperone.**

Dorms:

Chaperones will stay in the same dorms with the students and may stay in the same room. Schools supervise the dorms. Help water conservation by reminding the students only one shower per day.

Damages:

Schools are held responsible for any property or building damages done by their students during their stay.

Free Time:

Recreational "free time" gives the students a break from taking in information and allows them to let out energy stored up during the previous learning session. Volleyballs, footballs, and Frisbees are available. Since "Free time" is the CIMI instructor's time off, the school's chaperones are to be responsible for supervision and general discipline during this time.

Timing:

Keep students on time to programs and meals. This will maximize time in program and ensure warm food for all. Sit at tables with students and supervise meals. This will to help reduce noise and facilitate a pleasant dining experience.

DAILY SCHEDULE

7:00 AM	Rise And Shine	12:45/1:00 PM	Free Time
7:15/8:00 AM	Breakfast	1:45 PM	Afternoon Program
7:45/8:30 AM	Free Time	5:15/6:00 PM	Dinner
9:00AM	Morning Program	7:00/7:30PM*	Evening Program
12:15/1:00 PM	Lunch	9:00 PM	Quiet Hours
		9:30 PM	Lights Out

- Times are adjusted for Daylight Savings
- Meal times are dependant on first or second seating

Quiet hours are 9:00 PM to 7:00 AM for all participants. It is the chaperone's responsibility to help students respect quiet hours. Our program is energy intensive; everybody will need and want sleep.

PLEASE SUPPORT THE PROGRAM IN THE FOLLOWING WAYS:

- Always wear shoes.
- No hiking, tide pooling or water activities without CIMI supervision.
- Comply with all instructions of the CIMI staff.
- Be courteous to the CIMI staff and encourage it in the students.
- Keep students out of restricted areas.
- Keep noise to an acceptable level.

- Do not litter and encourage students to pick up any litter.
- Curb general horseplay. A simple X-ray or stitch is at least a *four-hour round trip*.
- Keep the dorms and restrooms clean. Do not put anything but toilet paper in the toilets. **Please instruct the females in your group NOT to dispose of sanitary napkins or tampons in the toilets. Receptacles for that purpose have been provided.**
- Motivate all students to be on time for all programs sessions and meals.
- Students may not smoke. Adults please smoke only in designated areas.
- **No alcoholic beverages and no illegal drugs.**
- Dorm quiet hours are 9:00 pm - 7:00 am.
- **Bring an alarm clock or watch with an alarm setting.**
- No rock throwing.
- No shell or animal collecting. We wish to preserve our marine environment.
- **Students may not use the telephone. If there is an emergency, the group leader will be able to call the appropriate people.**
- Conserve water. One shower a day.

please copy for the student and chaperones

2.2 WHAT TO BRING

There are many items that students will want to bring to CIMI. Some are necessary and some may just be extra baggage that they may never use. This is a field trip and the students should pack appropriately.

***We advise that students bring no more than they can comfortably carry.** Your students will have to carry their luggage not only on and off the boat, but also up a long field to their dorms when they arrive at Toyon Bay. They will have to repeat that process on their day of departure.

Essential items:	Not essential but desired by many:	Do Not Bring:
Old shirts and shorts	Sunhat	Knives
Jeans or old slacks	Sunglasses	Spearguns
Long sleeved shirt	Camera and film	Firecrackers
Raincoat or poncho	Pillow	Curling irons
Underwear	Day Pack	Valuables
Bath towel	Contact lenses (Glasses cannot be worn under masks. CIMI does offer optical snorkeling masks, however)	Alcohol or drugs
Toothbrush and toothpaste	Extra swim suit	TV's, radios, etc.*
Swim suit		Video games
Large beach towel		Watergun/balloons
Warm sleeping bag (or extra blanket)		Money for souvenirs
Gum, candy, seeds		
Flashlight		Cell Phones(camp is out of range)
Tennis shoes or boots for hiking		Fishing gear
Sunscreen		
Water bottle		
Warm sweater or sweatshirt		

→ Be sure to mark all clothing before arrival on the island.

→ If students used IPODS or electronics on the trip over, please collect these and leave them in the CIMI Program Office until departure. CIMI does not assume responsibility for lost/stolen items.

Please pack personal gear in a suitable container. Soft luggage or duffel bag is best. Also, tying the bag to the rest of the luggage can make it harder to load on and off the boat. Advise students to keep their pieces separate and well marked with their name, address, school name, and colored yarn.

Inclement Weather:

The weather on Catalina Island is usually very good. However, it is possible to have rain, wind, fog, or a combination of these conditions at any time. Programs will occur as planned or will be altered to meet the conditions. All students and chaperones **must** have rain gear. Plastic trash bags can function as an inexpensive, although not very durable, rain poncho. If there are bad winds, it is possible that your boat transportation will be postponed until the winds have died down. **Be prepared for all types of weather!**

→ It is prudent to pack a plastic bag for wet articles from rain or last-morning water activities.

Departure Procedure:

Prior to departure from Toyon Bay, students will sweep out and vacuum their dorms, clean and mop bathrooms, clear the sand off the mattresses and pick up any debris around the dorm. Instructors will check each dorm for cleanliness and damages before dismissing the group. Luggage will be carried by the students to the pier to await departure.

→ The boat may return to Long Beach via other camps or Two Harbors.

2.3 SAFETY INFORMATION

Emergency Procedures:

In the event of a fire or other facility emergency, adults are responsible for moving students to an appropriately safe location. This procedure will be covered during the teachers meeting upon arrival. Students should not tamper with fire fighting equipment. Students who discharge fire extinguishers without just cause will have to pay a \$100.00 recharging fee.

Fire:

If any person spots a fire, they should sound the alarm immediately, report to the program office and explain the situation to CIMI staff. Upon hearing the alarm, all guests at Toyon Bay are to report to the soccer field. The teachers are to account for all their students.

DO NOT ATTEMPT TO FIGHT THE FIRE!

Lost child:

The CIMI staff has been instructed as to the proper procedure for a lost child. Paramedics and the Sheriff are available for emergency situations.

Medical Procedures:

If an accident of any type occurs, report it immediately to a CIMI staff member. If first aid is required, it will be administered by a qualified individual. All CIMI instructional staff are certified in First Aid, CPR and Lifeguarding. Paramedics will be contacted for major accidents. Problems requiring a doctor's attention, other than accidents handled by paramedics, will have to go to Avalon or the mainland for attention.

Student Medication:

The school group leader will be responsible for all medication required by their students.

Students with Communicable Diseases:

During the course of a visit, any student or other guest at Toyon Bay that shows symptoms of chicken pox, measles, or any other communicable disease will, following consultation with the paramedics or a doctor, be restricted from program participation and sent home at the earliest opportunity. Please do not bring any sick students or chaperones to Toyon Bay. Fevers, flu and colds are just an example. This policy is in consideration of the affected person's comfort and the health and well being of the remaining students and CIMI staff.

2.4 MEALS

All meals are set-up "buffet style" with a hot meal and a salad bar. Students will all come into the dining hall, sit down at their designated tables and wait to be dismissed. After each meal a clean-up crew from each school will stay behind to clean all tables and sweep the floor.

General Guidelines:

- All students and adults are to meet the Program Coordinator prior to meals for announcements.
- Students should enter the dining hall in an orderly fashion.
- All students will be responsible for bussing their own dishes, and putting their chairs away.
- A group of students from each school will stay after the meal, with a chaperone, to help clean the dining hall.

******Students need to be courteous and take only what they can eat.******

SAMPLE MENU

Breakfast:

- Pancakes and sausage or scrambled eggs and hash browns or sausage; fruit juice, milk
- Fruit bar: cereal selection, yogurts, fresh fruit, various jams and preserves, Danish, bagels or English muffins

Lunch:

- Pizza, hamburgers, corn-dogs or cold-cut sandwiches (one entree per lunch); fruit drink, water
- Salad bar: may consist of mixed greens, chopped veggies, cheese, croutons, canned fruit, 3-4 salad dressings, potato salad, pasta or soup

Dinner:

- Lasagna (meat and veggie), turkey, chicken or Mexican (one entree per dinner); milk, water
- Salad bar: same as lunch with vegetarian side dish
- Dessert: brownies, cookies, cake, ice cream

Note: This is a sample menu only. Food items are subject to change and vegetarians are accommodated at each meal. Prior to departure, the Assistant Program Director will contact the group leader for any special food needs or allergies. **Food is of high quality and there is plenty of it. Please refrain from bringing extra food or snacks as these will attract insects and rodents.**

3.0 PROGRAM DESCRIPTIONS

3.1 DAY PROGRAMS

Each student will have the opportunity to demonstrate basic snorkeling skills, as taught by the CIMI instructors, and to utilize these skills in exploring and discovering the marine environment. Students do not have to be great swimmers as the wetsuit acts as a floatation device. Non-swimmers or poor swimmers may thoroughly enjoy the experience if they have confidence in themselves.

Everyone will be doing at least one snorkeling session while at Toyon Bay. All participants in our snorkeling program will use snorkeling equipment consisting of a full-length three-piece wetsuit, hood, booties, mask, snorkel and fins. The proper use of this equipment ensures greater safety and a more pleasant experience. Likewise, proper care and maintenance of equipment is essential. Both of these topics will be covered thoroughly by CIMI instructors during the first snorkel introduction, and students will be reminded during subsequent snorkels.

→ If any of your students have personal equipment that they wish to bring, make sure that it is well-marked. For those students with impaired vision, contact lenses have not presented problems when worn under a properly fitted mask. Glasses **cannot** be worn under a mask. CIMI does offer optical masks for students in need of them.

ORIENTATION SNORKEL (required of all groups regardless of age or ability)

Pre-snorkel: Discussion of care and use of snorkeling equipment, safety and the importance of the buddy system will be emphasized.

Snorkeling skills:

The basic skills covered are adjustment of equipment, clearing mask & snorkel, and breathing through a snorkel. This will be followed up by swimming with fins and snorkeling along the surface. Time to explore Toyon Bay!

Post-snorkel:

There will be a wrap-up discussion of the snorkel and review of what was seen.

BASIC SNORKEL

After the first snorkel, the objective is to look at the various marine habitats of Toyon Bay (sandy bottoms, rocky shorelines, and kelp) and observe the animals in these environments. It usually begins with the instructors describing various fish and animals that are commonly observed. Depending on student's ability, they may have the option to wear weight belts. The second snorkel is usually a more exciting and rewarding experience. The students are more comfortable and recognize many of the organisms that they have been learning about in the labs. This dive usually ends with a post-dive discussion before cleaning up.

MARINE ECOLOGY SNORKEL

Students will be exploring different habitats and observing animal behaviors. This snorkel may be at a different location. It will have pre- and post-dive discussions that are applicable to the laboratories. Students should see an improvement in their snorkeling ability by this time.

MARINE LAB PROGRAM OPTIONS:

Students will have the opportunity to experience at least one program session in the labs. Occasionally, in the case of very large groups, not all research groups will be assigned to the same labs. The Toyon Bay Program Office will try to accommodate all your program needs. Due to the limited availability of space, however, it is possible that you will not always get your first choice.

FISH - SHARK - MARINE ALGAE ROTATION:

Fish lab: Several aquariums are part of the fish lab experience. Students will be exposed to the fishes found commonly around Catalina Island. They will also be introduced to the classification, anatomy, behavior and other adaptive features of many fishes. This lab compliments the snorkeling experience, wherein the students become more familiar with fishes they will be seeing.

Shark Lab: The characteristic biology of sharks is explored before entering the central feature of this lab, a large tank filled with live sharks and rays for the students to touch. This is an exciting time for all students and helps mitigate the myth that sharks are dangerous.

Algae lab: As a major habitat and food source for marine animals of Catalina, algae (seaweed) merits special consideration. Students will be introduced to the many uses of algae, characteristics of different divisions of algae and the principal adaptive differences between algae and terrestrial plants. They will also prepare a pressed sample of common species of algae for use back at school.

PLANKTON - INVERTEBRATE - (YOUR CHOICE) ROTATION:

Plankton Lab: In this laboratory, the students are introduced to the world of plankton. Using digital microscopes the students will divide into teams and identify their live plankton sample. Each team has its own digital microscope and monitor. The CIMI instructor has a SMART Board that can show any student's sample to the entire class. Students will discuss the "food web" and some effects pollution has on the world's oceans. The study of "micro plankton" leads directly to the invertebrate laboratory.

Invertebrate lab: Familiarization with the variety of marine invertebrates is fun and easy when students can get a close up look, through our touch tank and aquariums, of species common to Catalina. This laboratory includes a touch tank with live animals from the phyla of Porifera, Cnidaria, Echinodermata, Annelida, Mollusca, and Arthropoda. In addition to the touch tank, there is a lobster tank, octopus tank, and phylum tanks. Student participation facilitates the study of classification, species identification, adaptation and natural history by closely examining animals.

Your Choice: Pick one of the following activities to complete the rotation.

- **Oceanography** - Students will learn the basic principles of oceanography and perform hands-on oceanographic research from our float.
- **Marine Mammals** - Students are introduced to marine mammals, their adaptations and survival strategies in our marine mammal lab.
- **Mini Hike** - This hike will be an abridged version of the terrestrial lab and hike. It will expose the students to local geology, flora and fauna, as well as introduce students to the natural history of Santa Catalina and it's Native Islanders.

TERRESTRIAL LAB - HIKE:

Terrestrial Lab: In this laboratory, the students are exposed to many of the island's unique flora and fauna. Through a series of learning stations, the students will see or handle Native Islander artifacts, live snakes, various minerals, skulls and bones, skins, and rocks. The laboratory has several terrariums with live reptiles (gopher and king snakes, amphibians, and lizards). In addition there are mounted goats, deer, pigs, and bison along with various birds. This is a great introduction to island ecology.

Hike: There are several trails within our canyons that are perfect for all ages and skills. Students will see, touch, smell and possibly taste a variety of plants on the island. Typical hikes cover the subjects of edible and useful plants, streambed ecology, feral animals and scatology. Students will explore methods of colonization by plants and animals, why islands are unique and learn of the Native Islanders history here on Santa Catalina and the Channel Islands. This is always a learning experience.

CLIMBING WALL - INITIATIVES:

Climbing Wall: Students will be able to challenge themselves on our 12-lane climbing wall. This program includes instruction in basic climbing techniques and safety. All necessary equipment is provided, and no previous climbing experience is needed. Students work at their own pace. Suitable for all ability levels.

Initiatives: Initiatives focus on teamwork, communication decision-making and problem solving. Students will set and maintain high standards and create a supportive environment for themselves and each other by meeting and overcoming physical and mental challenges. Some activities involve more perceived risk while being safely monitored by an instructor. Every member of the group participates, and initiatives can be customized for the particular group. These activities are designed to be both fun and challenging.

FIVE DAY PROGRAM OPTIONS:

Ocean Kayak:

(Full Day or Half Day)

Ocean Kayaking is an exciting and empowering experience for all students. Students will first become familiar with the basic parts of an ocean kayak. Once orientated to the kayak, students will begin learning their paddling skills on land. After the land practice session, students will don a personal floatation device (lifejacket), booties, and a paddling jacket (when cold). Under the close supervision of a CIMI instructor, students will board their kayaks and head out onto the protected waters around Toyon Bay. While on the water, students will review their skills and become more comfortable with their kayak. Students will then embark on a group coastal tour along Catalina's shoreline.

Day Hike:

(Full Day)

Five day groups have a chance for a longer hike. During the daylong excursion, the group will hike to a lake where they will be able to explore. They will eat a picnic lunch before returning to Toyon Bay.

3.2 EVENING PROGRAMS

These programs are especially important to the total CIMI experience and there are several options. We are very flexible and if you have a different evening option, let us know. Schools with long travel times on the day of arrival should think carefully about evening program selection. Students can either be overly 'wound up' or very tired in response to the long trip.

Astronomy Night Hike: This program involves hiking up several trails and exploring the night sky. Students will be able to view planets and constellations as pointed out by the instructor in the sky or through the use of an interactive computer program called Stellarium. Instructors can also use a storytelling approach. They share mythological stories of the stars, planets, sun or moon to highlight personal and cultural relationships with the night sky in addition to the earth's physical relationship to the universe.

Marine Mammals: This program allows the students to see a variety of articulated marine mammal skeletons, including a Gray Whale, sea lions, seals, sea otters, and dolphins. They will be able to touch a variety of bones and skulls, feel pelts, and interact with self-quizzing displays. **60 students maximum.**

Squid Dissection: This activity explores the general biology of the squid. Students start the activity by developing an information base of what is known about squid. They add to this knowledge by engaging in a simple dissection of a squid.

Creatures of the Night: This program focuses on the adaptations of organisms whose survival and defense strategies are adapted for a nocturnal existence and the deep sea environment. Interactive games and activities, including a dark maze, can be used to emphasize adaptations.

Night Snorkel: Night snorkeling is an exciting activity. Students will use underwater lights to observe the nocturnal life in our bay. Due to the cost of batteries for lights and glow sticks for snorkels, there is an additional cost of **\$5.00** per person. Another activity should be planned for those students who choose not to participate.

Climbing Wall: Students challenge themselves and encourage other members in the group on the climbing wall. For the evening program, we light up the area and play music. Staff instruct students in basic climbing techniques and safety. Equipment is provided, and no previous climbing experience is necessary.

Santa Clara Island Game: This particular program involves students designing their own island and having to consider issues such as development, conservation, and resources, on island ecology.

Catalina Island Above and Below: Students watch a video about the land and sea habitats and inhabitants of Catalina Island. After the video, students are presented with conservation problems and debate solutions.

Campfire: At the campfire, each school may do whatever activity they desire. CIMI staff will light the campfire and provide marshmallows, but individual school program is up to the teachers and chaperones. Groups can choose this as their entire evening program or add this on after their scheduled evening program.

Sleep option: After a long day, certain children may be too tired to attend evening program. For those campers who wish to do so, sleep is always an option keeping in mind that an adult must be in the dorm with the campers.